

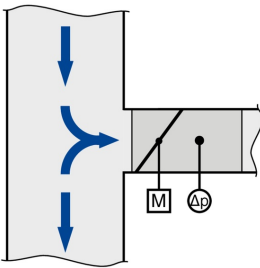

VAV TERMINAL UNIT TYPE
TA-SILENZIO



TESTED TO VDI 6022



FOR ALL UPSTREAM
CONDITIONS

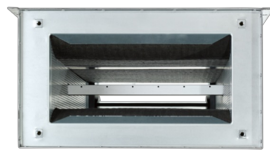

RECTANGULAR
CONNECTIONS ON BOTH
ENDS

TYPE TA-SILENZIO

[Configure now](#)

FOR EXTRACT AIR SYSTEMS WITH DEMANDING ACOUSTIC REQUIREMENTS AND LOW AIRFLOW VELOCITIES

Rectangular VAV terminal units for the extract air control in buildings with variable air volume systems, demanding acoustic requirements and low airflow velocities

- Highly effective integral attenuator
- Optimised for airflow velocities of 0.7 – 6 m/s
- High control accuracy even in case of unfavourable upstream conditions
- Compact construction with rectangular connections on both ends
- Electronic control components for different applications (Easy, Compact, Universal, and LABCONTROL)
- Closed blade air leakage to EN 1751, class 4
- Casing air leakage to EN 1751, class B

Optional equipment and accessories

- Acoustic cladding for the reduction of case-radiated noise
- Secondary silencer Type TS for the reduction of air-regenerated noise

Application

Application

- VARYCONTROL VAV terminal units of Type TA-Silenzio for the extract air flow control in variable air volume systems with low airflow velocities
- Closed-loop volume flow control using an external power supply
- Integral attenuator for demanding acoustic requirements
- Shut-off by means of switching (equipment supplied by others)

Special features

- Hygiene tested and certified
- Direct connection of ducting
- Factory set-up or programming and aerodynamic function testing
- Volume flow rate can later be measured and adjusted on site; additional adjustment device may be necessary

Nominal sizes

- 125, 160, 200, 250, 315



Description



Variants

- TA-Silenzio: Extract air unit
- TA-Silenzio-D: Extract air unit with acoustic cladding
- Units with acoustic cladding and/or secondary silencer Type TS for very demanding acoustic requirements
- Acoustic cladding cannot be retrofitted

Parts and characteristics

- Ready-to-commission unit which consists of mechanical parts and control components.
- Averaging differential pressure sensor for volume flow rate measurement
- Damper blade
- Integral attenuator
- Factory-assembled control components complete with wiring and tubing
- Aerodynamic function testing on a special test rig prior to shipping of each unit
- Set-up data is given on a label or volume flow rate scale affixed to the unit
- High control accuracy even in case of unfavourable upstream conditions

Attachments

- Easy controller: Compact unit with potentiometers
- Compact controller: Compact unit consisting of controller, differential pressure transducer and actuator
- Universal controller: Controller, differential pressure transducer and actuators for special applications
- LABCONTROL: Control components for air management systems

Useful additions

- Secondary silencer Type TS

Construction features

- Rectangular casing
- Replaceable seals
- Flanges on both ends for connection to ductwork
- Position of the damper blade indicated externally at shaft extension
- Thermal and acoustic insulation (lining)

Materials and surfaces

- Casing made of galvanised sheet steel
- Damper blade and differential pressure sensor made of aluminium
- Lining is mineral wool
- Plastic bearings

Variant with acoustic cladding (-D)

- Acoustic cladding made of galvanised sheet steel
- Lining is mineral wool
- Rubber elements for the insulation of structure-borne noise

Mineral wool

- To EN 13501, fire rating class A1, non-combustible
- RAL quality mark RAL-GZ 388
- Biosoluble and hence hygienically safe according to the German TRGS 905 (Technical Rules for Hazardous Substances) and EU directive 97/69/EG
- Faced with glass fibre fabric as protection against erosion through airflow velocities of up to 20 m/s
- Inert to fungal and bacterial growth

Standards and guidelines

- Hygiene conforms to VDI 6022
- VDI 2083, air cleanliness class 3, and US standard 209E, class 100

- Closed blade air leakage to EN 1751, class 4
- Meets the increased requirements of DIN 1946, part 4, with regard to the acceptable closed blade air leakage
- Casing air leakage to EN 1751, class B

Maintenance

- Maintenance-free as construction and materials are not subject to wear

TECHNICAL INFORMATION

Function, Technical data, Quick sizing, Specification text, Order code, Related Products ^

Functional description

The VAV terminal unit is fitted with a differential pressure sensor for measuring the volume flow rate.

The control components (attachments) include a differential pressure transducer that transforms the differential pressure (effective pressure) into an electric signal, a controller, and an actuator; the control functions can be achieved with an Easy controller, with a Compact controller, or with individual components (Universal).

For most applications, the setpoint value comes from a room temperature controller.

The controller compares the actual value with the setpoint value and alters the control signal of the actuator if there is a difference between the two values.

An integral attenuator reduces the noise that is created by the restriction of the airflow.

Schematic illustration of the TA-Silenzio

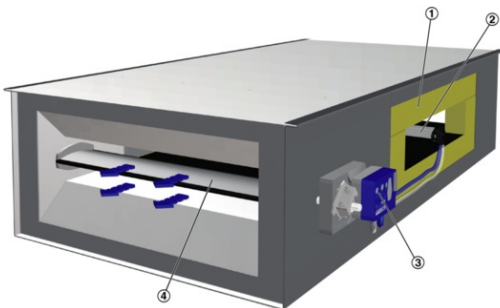

- ① Differential pressure sensor
- ② Indicator light
- ③ Control components, e.g. an Easy controller
- ④ Damper blade with seal

Volume flow rate ranges

The minimum differential pressure of VAV terminal units is an important factor in designing the ductwork and in rating the fan including speed control.

Sufficient duct pressure must be ensured for all operating conditions and for all control units. The measurement points for fan speed control must be selected accordingly.

The volume flow rates given for VAV terminal units depend on the nominal size and on the control component (attachment) that is installed. The table gives the minimum and maximum values for a VAV terminal unit. Some control components may only have a limited volume flow rate range. This applies in particular to control components with a static differential pressure transducer. For volume flow rate ranges for all control components refer to our Easy Product Finder design programme.

Nominal size	V l/s	V m³/h	TZ-Si Δp_{st} min Pa	ΔV ± %
125	30	108	5	8
	30	108	5	8
125	70	252	20	7
	70	252	10	7
125	125	450	60	5
	125	450	35	5
125	180	648	120	5
	180	648	65	5
160	45	162	5	8
	45	162	5	8
160	110	396	10	7
	110	396	20	7
160	195	702	55	5
	195	702	30	5
160	275	990	105	5
	275	990	55	5
200	65	234	5	8
	65	234	5	8
200	150	540	10	7
	150	540	20	7
200	265	954	30	5
	265	954	60	5
200	380	1368	120	5
	380	1368	55	5
250	85	306	5	8
	85	306	5	8
250	200	720	10	7
	200	720	20	7
250	345	1242	60	5
	345	1242	30	5
250	495	1782	115	5
	495	1782	60	5
315	145	522	5	8
	145	522	5	8
315	335	1206	15	7
	335	1206	20	7
315	590	2124	35	5
	590	2124	50	5
315	840	3024	65	5
	840	3024	105	5

Nominal sizes	125 – 315
Volume flow rate range	30 – 840 l/s or 108 – 3024 m³/h
Volume flow rate control range (unit with dynamic differential pressure measurement)	Approx. 10 to 100% of the nominal volume flow rate
Minimum differential pressure	5 – 65 Pa
Maximum differential pressure	1000 Pa
Operating temperature	10 – 50 °C

Quick sizing tables provide a good overview of the room sound pressure levels that can be expected. Approximate intermediate values can be interpolated. Precise intermediate values and spectral data can be calculated with our Easy Product Finder design programme.

The first selection criteria for the nominal size are the actual volume flow rates V_{min} and V_{max} . The quick sizing tables are based on generally accepted attenuation levels. If the sound pressure level exceeds the required level, a larger air terminal unit and/or a silencer is required.

TA-Silenzio, Sound pressure level at differential pressure 150 Pa

Nominal size	V		Air-regenerated noise		Case-radiated noise	
			①	②	①	③
Nominal size	V		LPA	LPA1	LPA2	LPA3
	l/s	m³/h	dB(A)			
125	30	108	13	3	10	8
	70	252	23	13	19	19
125	125	450	30	21	26	26
	180	648	33	26	30	31
160	45	162	14	4	13	10
	110	396	25	14	22	21
160	195	702	30	21	29	29
	275	990	33	26	34	34
200	65	234	13	0	12	8
	150	540	22	10	22	18
200	265	954	26	16	28	26
	380	1368	29	21	33	31
250	85	306	14	2	13	8
	200	720	22	10	23	19
250	345	1242	26	15	30	26
	495	1782	29	19	34	31
315	145	522	16	3	17	12
	335	1206	22	9	27	23
315	590	2124	26	14	35	31
	840	3024	29	20	39	36

① TA-Silenzio

② TA-Silenzio with secondary silencer TS

③ TA-Silenzio-D

Rectangular VAV terminal units for variable and constant air volume systems for demanding acoustic requirements, suitable for extract air, available in 5 nominal sizes.

High control accuracy even in case of unfavourable upstream conditions.

Ready-to-commission unit which consists of the mechanical parts and the electronic control components. Each unit contains an averaging differential pressure sensor for volume flow rate measurement, a damper blade, and an integral attenuator. Factory-assembled control components complete with wiring and tubing.

Differential pressure sensor with 3 mm measuring holes (resistant to dust and pollution)

Both ends suitable for the connection of air duct profiles.

Casing with acoustic and thermal insulation.

Position of the damper blade indicated externally at shaft extension.

Closed blade air leakage to EN 1751, class 4.

Casing air leakage to EN 1751, class B.

Complies with VDI 2083, clean room class 3, and US standard 209E, class 100. Hygiene complies with VDI 6022, DIN 1946, part 4, as well as EN 13779 and VDI 3803.

Special features

- Hygiene tested and certified
- Direct connection of ducting
- Factory set-up or programming and aerodynamic function testing
- Volume flow rate can later be measured and adjusted on site; additional adjustment device may be necessary

Materials and surfaces

- Casing made of galvanised sheet steel
- Damper blade and differential pressure sensor made of aluminium
- Lining is mineral wool
- Plastic bearings

Variant with acoustic cladding (-D)

- Acoustic cladding made of galvanised sheet steel
- Lining is mineral wool
- Rubber elements for the insulation of structure-borne noise

Mineral wool

- To EN 13501, fire rating class A1, non-combustible
- RAL quality mark RAL-GZ 388
- Biosoluble and hence hygienically safe according to the German TRGS 905 (Technical Rules for Hazardous Substances) and EU directive 97/69/EG
- Faced with glass fibre fabric as protection against erosion through airflow velocities of up to 20 m/s
- Inert to fungal and bacterial growth

Technical data

- Nominal sizes: 125 – 315
- Volume flow rate range: 30 to 840 l/s or 108 to 3024 m³/h
- Volume flow rate control range (unit with dynamic differential pressure measurement): approx. 10 to 100 % of the nominal volume flow rate
- Minimum differential pressure: 5 – 65 Pa
- Maximum differential pressure: 1000 Pa

Attachments

Variable volume flow control with electronic Easy controller to connect an external control signal; actual value signal can be integrated into the central BMS.

- Supply voltage 24 V AC/DC
- Signal voltages 0 – 10 V DC
- Possible override controls with external switches using volt-free contacts: CLOSED, OPEN, V_{\min} and V_{\max}
- Potentiometers with percentage scales to set the volume flow rates V_{\min} and V_{\max}
- The actual value signal relates to the nominal volume flow rate such that commissioning and subsequent adjustment are simplified
- Volume flow rate control range: approx. 10 – 100 % of the nominal volume flow rate
- Clearly visible external indicator light for signalling the functions: Set, not set, and power failure

Electrical connections with screw terminals. Double terminals for looping the supply voltage, i.e. for the simple connection of voltage transmission to the next controller.

Sizing data

- V _____ [m³/h]
- Δp_{st} _____ [Pa]

Air-regenerated noise

- L_{PA} _____ [dB(A)]

Case-radiated noise

- L_{PA} _____ [dB(A)]

This specification text describes the general properties of the product. Texts for variants can be generated with our Easy Product Finder design programme.

Order example: TA-Silenzio/250/BC0/M0/500-1500 m³/h

Acoustic cladding	Without
Nominal size	250
Attachment	Compact controller
Operating mode	Master
Signal voltage range	0 – 10 V DC
Volume flow rate	500 – 1500 m³/h

Order example: TA-Silenzio/200/ELAB/EC/E0/300-1000

Acoustic cladding	Without
Nominal size	200
Attachment	EASYPAC controller TCU3 with fast-running actuator
Equipment function	Extract air controller
External volume flow rate setting	Voltage signal 0 – 10 V DC
Operating values	300 – 1000 m³/h

TA-Silenzio – D / 200 / B1B / E 0 / 400 – 1200 / NO



TA-Silenzio – D / 200 / Easy



extract air

1 Type

TA-Silenzio VAV terminal unit,

2 Acoustic cladding

No entry: none

D With acoustic cladding

control – extract air

3 Nominal size

125

value signals

160

200

250

l/s), differential pressure [Pa]

315

(operating mode A)

4 Attachments (control component)

Example

actuators

Easy Easy controller

BC0 Compact controller

B13 Universal controller

5 Operating mode

E Single

M Master

S Slave

F Constant value

A Differential pressure

6 Signal voltage range

For the actual and setpoint

0 0 – 10 V DC

2 2 – 10 V DC

7 Volume flow rates [m³/h or

V_{min} – V_{max} for factory setting
ΔP_{min} for factory setting

8 Damper blade position

Only with spring return

NO Power off to OPEN

NC Power off to CLOSE

TA-Silenzio – D / 200 / ELAB / RE / ULZ / LAB / ...

1 2 3 4 5 7 8 9

TA-Silenzio – D / 200 / ELAB / EC – E0 / ULZ / ...

1 2 3 4 5 6 7 9

extract air

1 Type

TA-Silenzio VAV terminal unit,

interface

Option 2: Communication

No entry: none

L EM-LON for LonWorks

B EM-BAC-MOD-01 for

M EM-BAC-MOD-01 for

I EM-IP for BACnet/IP,

R EM-IP with real time clock

Option 3: Automatic zero point

No entry: none

Z EM-AUTOZERO Solenoid

2 Acoustic cladding

No entry: none

D With acoustic cladding

FTT-10A

BACnet MS/TP

Modbus RTU

Modbus/IP and webserver

3 Nominal size

125

correction

160

		valve for automatic zero point correction	
	200		
	250		
	315	(equipment function) has been deactivated	
		(laboratories)	
		(clean rooms)	
	4 Attachments (control component)		
	ELAB EASYLAB controller	active	
		system (LAB)	
	5 Equipment function	system	
	Room control		
	RE Extract air control		
	PC Differential pressure		
	Single operation		
	EC Extract air controller		
	6 External volume flow rate setting		
	Only for single operation	difference	
	E0 Voltage signal	(only with differential pressure control)	
	E2 Voltage signal	operation'	
	2P Switch contacts (provided		
	3P Switch contacts (provided		
	F Volume flow rate constant		
	7 Expansion modules	display	
	Option 1: Power supply No entry: 24 V AC		
	T EM-TRF for 230 V AC		
	U EM-TRF-USV for 230 V AC,		
	provides uninterruptible power supply (UPS)		
			8 Additional functions
			Only for room control
			Room management function
			LAB Extract air led system
			CLR Supply air led system
			Room management function is
			LAB-RMF Extract air led
			CLR-RMF Supply air led
			9 Operating values [m³/h or l/s,
			For equipment function 'room
			Total room extract air/supply air
			V ₁ : Standard mode
			V ₂ : Reduced operation
			V ₃ : Increased operation
			V ₄ : Constant room supply air
			V ₅ : Constant room extract air
			V ₆ : Supply air/extract air
			Δp _{setpoint} : Setpoint pressure
			For equipment function 'single
			E0, E2: V _{min} / V _{max}
			2P: V ₁ / V ₂
			3P: V ₁ / V ₂ / V ₃
			F: V ₁
			Useful additions
			Room control panel
			BE-LCD-01 40-character

Attachments

[Type Easy](#)
[Type Compact, dynamic](#)
[Type Compact, static](#)
[Type Universal, dynamic](#)
[Type Universal, static](#)

Additional products

[Type TS](#)

TA-Silenzio

- VAV terminal unit for the control of variable extract air volume flows

TA-Silenzio-D

- VAV terminal unit with acoustic cladding for the control of variable extract air volume flows
- For rooms where the case-radiated noise of the unit is not sufficiently reduced by a false ceiling
- The ducts for the room under consideration must have adequate acoustic insulation (to be provided by others) on the fan end
- Acoustic cladding cannot be retrofitted

TA-Silenzio, VARYCONTROL control components

Order code detail	Controlled variable	Controller	Differential pressure transducer	Actuator
Easy controller				
Easy	Volume flow rate	Easy controller TROX	Dynamic, integral	Integral
Compact controller, dynamic				
BC0	Volume flow rate	Compact controller with MP bus interface TROX/Belimo	Dynamic, integral	Integral
BL0	Volume flow rate	Compact controller with LonWorks interface TROX/Belimo	Dynamic, integral	Integral
BM0	Volume flow rate	Compact controller with Modbus RTU interface (with connecting cable) TROX/Belimo	Dynamic, integral	Integral
BM0-J6	Volume flow rate	Compact controller with Modbus RTU interface (with socket) TROX/Belimo	Dynamic, integral	Integral
XB0	Volume flow rate	Compact controller TROX/Gruner	Dynamic, integral	Integral
LN0	Volume flow rate	Compact controller Siemens	Dynamic, integral	Integral
LK0	Volume flow rate	Compact controller with KNX interface Siemens	Dynamic, integral	Integral
Compact controller, static				
SA0	Volume flow rate	Compact controller with SLC interface Sauter	Static, integral	Integral
SC0	Volume flow rate	Compact controller with SLC interface Sauter	Static, integral	Fast-running actuator, integral
Universal controller, dynamic				
B13	Volume flow rate	Universal controller TROX/Belimo	Dynamic, integral	Actuator
B1B	Volume flow rate	Universal controller TROX/Belimo	Dynamic, integral	Spring return actuator

XC3	Volume flow rate	Universal controller TROX/Gruner	Dynamic, integral	Spring return actuator
Universal controller, static				
BP3	Volume flow rate	Universal controller with MP bus interface TROX/Belimo	Static	Actuator
BPB	Volume flow rate	Universal controller with MP bus interface TROX/Belimo	Static	Spring return actuator
BPG	Volume flow rate	Universal controller with MP bus interface TROX/Belimo	Static	Fast-running actuator
BB3	Volume flow rate	Universal controller TROX/Belimo	Static	Actuator
BBB	Volume flow rate	Universal controller TROX/Belimo	Static	Spring return actuator
XD1	Volume flow rate	Universal controller TROX/Gruner	Static, integral	Actuator
XD3	Volume flow rate	Universal controller TROX/Gruner	Static, integral	Spring return actuator
BR3	Differential pressure	Universal controller with MP bus interface TROX/Belimo	Static, integral 100 Pa	Actuator
BRB	Differential pressure	Universal controller with MP bus interface TROX/Belimo	Static, integral 100 Pa	Spring return actuator
BRG	Differential pressure	Universal controller with MP bus interface TROX/Belimo	Static, integral 100 Pa	Fast-running actuator
BG3	Differential pressure	Differential pressure controller TROX/Belimo	Static, integral 100 Pa	Actuator
BGB	Differential pressure	Differential pressure controller TROX/Belimo	Static, integral 100 Pa	Spring return actuator
XE1	Differential pressure	Differential pressure controller TROX/Gruner	Static, integral 100 Pa	Actuator
XE3	Differential pressure	Differential pressure controller TROX/Gruner	Static, integral 100 Pa	Spring return actuator

TA-Silenzio, LABCONTROL control components

Order code detail	Controlled variable	Controller	Differential pressure transducer	Actuator
EASYLAB				
ELAB	Room extract air Room pressure Single controller	EASYLAB controller TCU3	Static, integral	Fast-running actuator

Nominal size	L mm	B ₃ mm	H ₃ mm	B mm	B ₁ mm	H mm	H ₁ mm	m kg
125	1035	300	236	198	232	152	186	17
160	1035	410	236	308	342	152	186	21
200	1250	560	281	458	492	210	244	32
250	1250	700	311	598	632	201	235	41
315	1250	900	361	798	832	252	286	54

Nominal size	L mm	B ₃ mm	H ₃ mm	B mm	B ₁ mm	H mm	H ₁ mm	m kg
125	1035	380	316	198	232	152	186	32
160	1035	490	316	308	342	152	186	38
200	1250	640	361	458	492	210	244	64
250	1250	780	391	598	632	201	235	72
315	1250	980	441	798	832	252	286	91

TA-Silenzio

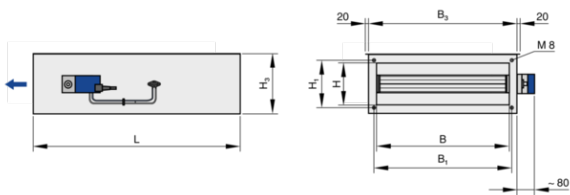

TA-Silenzio-D

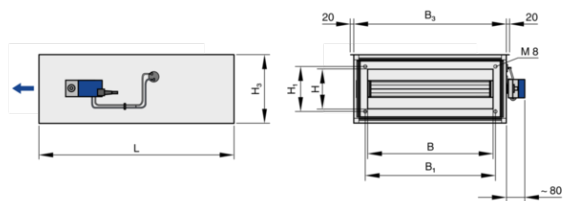

Detail of flange

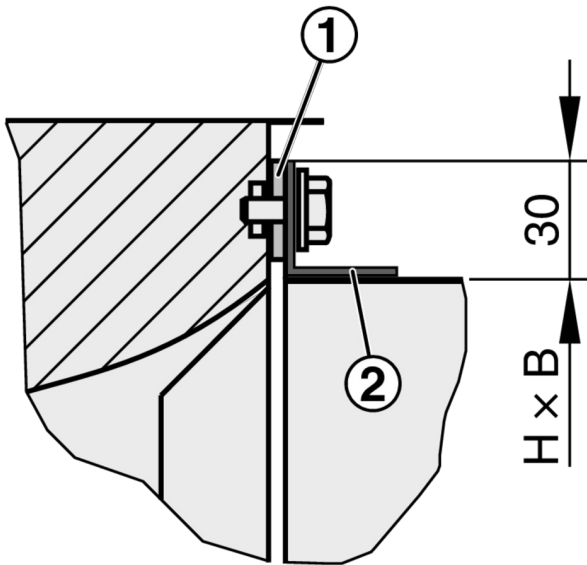

- ① Compressible seal, to be provided by others
- ② Flange

Installation details, Basic information and nomenclature



Installation and commissioning

- Any installation orientation (except units with static differential pressure transducer)
- Return edges of the casing with drilled holes suitable for M10 threaded rods
- TA-Silenzio-D: For constructions with acoustic cladding, ducts on the room side should have cladding up to the acoustic cladding of the controller

Upstream conditions

The volume flow rate accuracy ΔV applies to a straight upstream section of the duct. Bends, junctions or a narrowing or widening of the duct cause turbulence that may affect measurement. Duct connections, e.g. branches off the main duct, must comply with EN 1505. Some installation situations require straight duct sections upstream.

Space required for commissioning and maintenance

Sufficient space must be kept clear near any attachments to allow for commissioning and maintenance. It may be necessary to provide sufficiently sized inspection access openings.

Space required

Attachments	①	②	③
	mm		
VARYCONTROL			
Easy controller	700	300	300
Compact controller	700	300	300
Universal controller	700	300	300
LABCONTROL			
EASYLAB	700	350	400

Bend, vertical

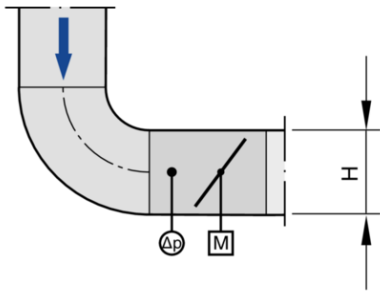

A bend – without a straight duct section upstream of the VAV terminal unit – has only a negligible effect on the volume flow rate accuracy.

Convergence of two airflows, vertical

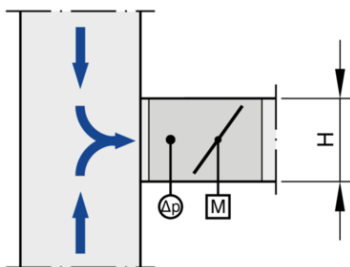

The stated volume flow rate accuracy ΔV will be achieved even when the VAV terminal unit is installed at a junction and at the point of convergence of two airflows.

Junction, horizontal

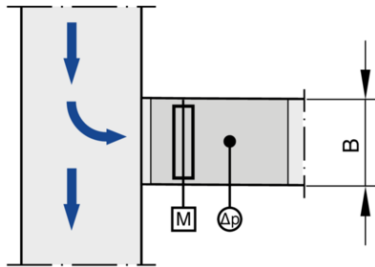

The stated volume flow rate accuracy ΔV will be achieved even when the VAV terminal unit is installed in a branch just off the main duct.

Convergence of two airflows, horizontal

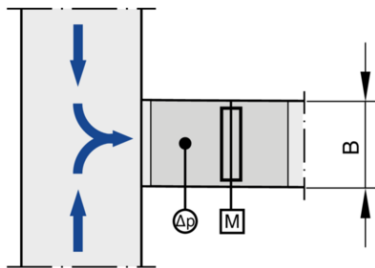

The stated volume flow rate accuracy ΔV will be achieved even when the VAV terminal unit is installed at a junction and at the point of convergence of two airflows.

Access to attachments

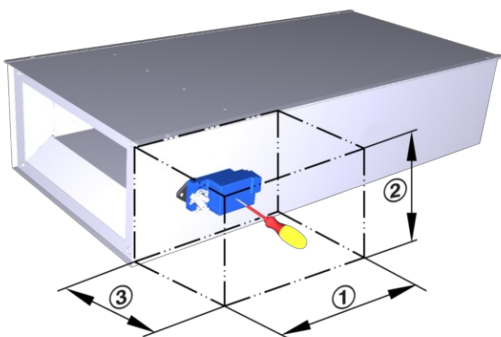

Access to battery pack

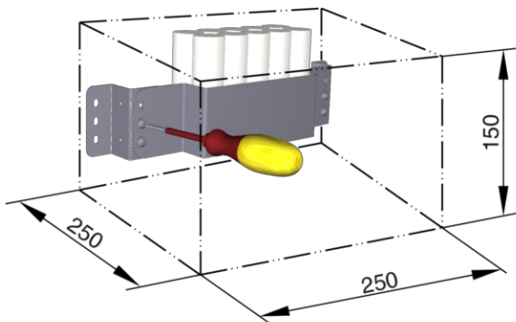

Separate space for fixing and accessing the battery pack (LABCONTROL EASYLAB accessory)

Principal dimensions

ØD [mm]

VAV terminal units made of stainless steel: Outside diameter of the spigot

VAV terminal units made of plastic: Inside diameter of the connecting spigot

ØD₁ [mm]

Pitch circle diameter of flanges

ØD₂ [mm]

Outside diameter of flanges

ØD₄ [mm]

Inside diameter of the screw holes of flanges

L [mm]

Length of unit including connecting spigot

L₁ [mm]

Length of casing or acoustic cladding

B [mm]

Duct width

B₁ [mm]

Screw hole pitch of flange (horizontal)

B₂ [mm]

Outside dimension of flange (width)

B₃ [mm]

Width of device

H [mm]

Duct height

H₁ [mm]

Screw hole pitch of flange (vertical)

H₂ [mm]

Outside dimension of flange (height)

H₃ [mm]

Unit height

n []

Number of flange screw holes

T [mm]

Flange thickness

m [kg]

Unit weight including the minimum required attachments (e.g. Compact controller)

Acoustic data**f_m [Hz]**

Octave band centre frequency

L_{PA} [dB(A)]

A-weighted sound pressure level of air-regenerated noise of the VAV terminal unit, system attenuation taken into account

L_{PA1} [dB(A)]

A-weighted sound pressure level of air-regenerated noise of the VAV terminal unit with secondary silencer, system attenuation taken into account

L_{PA2} [dB(A)]

A-weighted sound pressure level of case-regenerated noise of the VAV terminal unit, system attenuation taken into account

L_{PA3} [dB(A)]

A-weighted sound pressure level of case-regenerated noise of the VAV terminal unit with acoustic cladding, system attenuation taken into account

All sound pressure levels are based on 20 µPa.

Volume flow rates**V_{nom} [m³/h] and [l/s]**

Nominal volume flow rate (100 %)

- The value depends on product type and nominal size
- Values are published on the internet and in technical leaflets, and stored in the Easy Product Finder design software.
- Reference value for calculating percentages (e.g. V_{max})
- Upper limit of the setting range and maximum volume flow rate setpoint value for the VAV terminal unit

V_{min unit} [m³/h] and [l/s]

Technically possible minimum volume flow rate

- The value depends on product type, nominal size and control component (attachment)
- Values are stored in the Easy Product Finder design software
- Lower limit of the setting range and minimum volume flow rate setpoint value for the VAV terminal unit
- Depending on the controller, setpoint values below V_{min unit} (if V_{min} equals zero) may result in unstable control or shut-off

V_{max} [m³/h] and [l/s]

Upper limit of the operating range for the VAV terminal unit that can be set by customers

- V_{max} can only be smaller than or equal to V_{nom}
- In case of analogue signalling to volume flow controllers (which are typically used), the set maximum value (V_{max}) is allocated to the setpoint signal maximum (10 V) (see characteristic)

V_{min} [m³/h] and [l/s]

Lower limit of the operating range for the VAV terminal unit that can be set by customers

- V_{\min} should be smaller than or equal to V_{\max}
- Do not set V_{\min} smaller than $V_{\min \text{ unit}}$, otherwise the control may become unstable or the damper blade may close
- V_{\min} may equal zero
- In case of analogue signalling to volume flow controllers (which are typically used), the set minimum value (V_{\min}) is allocated to the setpoint signal minimum (0 or 2 V) (see characteristic)

V [m³/h] and [l/s]

Volume flow rate

ΔV [± %]

Volume flow rate tolerance from setpoint value

ΔV_{warm} [± %]

Volume flow rate tolerance for the warm air flow of dual duct terminal units

Differential pressure

Δp_{st} [Pa]

Static differential pressure

$\Delta p_{\text{st min}}$ [Pa]

Static differential pressure, minimum

- The static minimum differential pressure is equal to the pressure loss of the VAV terminal unit when the damper blade is open, caused by flow resistance (sensor tubes, damper mechanism)
- If the pressure on the VAV terminal unit is too low, the setpoint volume flow rate may not be achieved, not even when the damper blade is open
- Important factor in designing the ductwork and in rating the fan including speed control
- Sufficient duct pressure must be ensured for all operating conditions and for all terminal units, and the measurement point or points for speed control must have been selected accordingly to achieve this

Construction

Galvanised sheet steel

- Casing made of galvanised sheet steel
- Parts in contact with the airflow as described for the product type
- External parts, e.g. mounting brackets or covers, are usually made of galvanised sheet steel

Powder-coated surface (P1)

- Casing made of galvanised sheet steel, powder-coated RAL 7001, silver grey
- Parts in contact with the airflow are powder-coated or made of plastic
- Due to production, some parts that come into contact with the airflow may be stainless steel or aluminium, powder-coated
- External parts, e.g. mounting brackets or covers, are usually made of galvanised sheet steel

Stainless steel (A2)

- Casing made of stainless steel 1.4201
- Parts in contact with the airflow are powder-coated or made of stainless steel
- External parts, e.g. mounting brackets or covers, are usually made of galvanised sheet steel

Definition of noise

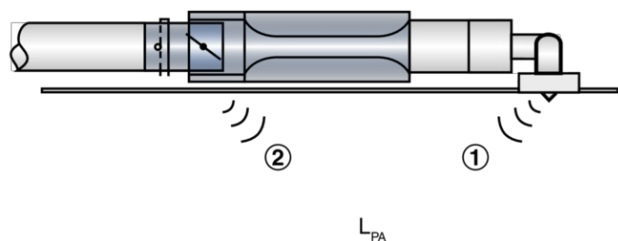

- ① Air-regenerated noise
- ② Case-radiated noise

Static differential pressure

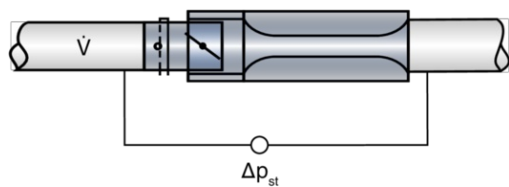

TROX Austria GmbH



Lichtblaustraße 15
1220 Wien, Austria

Telefon +43 1 250 43-0
Fax +43 1 250 43-34
E-Mail: trox-at@troxgroup.com

Online-Services

- > TROX Academy
- > Your contact partner
- > Online fault report

Service-Hotlines

Sales Austria
and technical consulting
+43 1 250 43 0
[Contact](#)

TROX IN SOCIAL WEB